

# Z SERIES FUZZY CONTROLLER X (48 X 48mm)

**DATA SHEET**
**PYX4**

The PYX is a state-the-art temperature controller offering enhanced control through the use of fuzzy logic. By employing fuzzy logic the PYX virtually eliminates system overshoot and effectively suppresses fluctuation of the process variable due to external disturbances. Fuzzy logic control is the technology of tomorrow offered today.

This controller features universal input circuitry and can accept signals from all thermocouple types, RTD's, and current/voltage sources. As well, the PYX-4 gives you the flexibility of choosing such available features as RS-485 communications, analog retransmission, dual output, heater break alarm, and loop break alarm, to name a few. The PYX-4 is the world's first 1/16 DIN fuzzy logic controller featuring high performance/cost ratio.



## FEATURES

### 1. Industry-first incorporation of fuzzy control in 48 mm-square controller

An improved response characteristic of controller is ensured thanks to the fuzzy control exercised while detecting an overshoot or a difference from the set temperature value due to a large disturbance. (Time taken for returning to the set value can be shortened and temperature variation width can be narrowed.)

### 2. Universal input

This means that a signal controller can respond to 11 kinds of thermocouples, resistance bulbs and voltage/current inputs.

### 3. Communication function comprised despite small size (option)

Because the general-purpose interface (RS-485) is mountable, a centralized monitoring/setting system aided by a personal computer can readily be configured. Upon building up a system, the size of this controller as small as 48 mm square is helpful for saving on the equipment installation area.

The communication protocol conforms either the Fuji Electric CC data line or Modbus® RTU.

### 4. Auto/Manual

Change auto-mode to manual-mode and manual operation can be done using front panel keys.

### 5. A wide variety of optional functions

- (1) A0 re-transmission (1 point)  
A0 is recordable in connection with Fuji's microjet recorder PHA/PHC.
- (2) Programmable alarm (2 points max.)  
2 kinds of alarm action can be registered selected from 16 kinds.
- (3) Dual output  
Dual control of heating and cooling operations are allowed  
(In this case, communication, A0 and HB (heater break) functions cannot be added).
- (4) Heater break alarm  
Use ALM1 or ALM2 output for heater break alarm (with heater current message-function)
- (5) Ramp/soak function  
4 ramp/soak-pair patterns are registrable.
- (6) External DI function (1 point)  
SV (setting value) can be changed a predetermined value according to external command input (DI).
- (7) Remote SV  
SV (setting value) can be controlled by external 1 to 5V DC analog input.

### 6. UL, C-UL approval

Modbus® is a registered trademark of Gould Modicon.

## GENERAL SPECIFICATIONS

- Size (H x W x D): 48 x 48 x 115mm
- Kinds of input:
  - Full multi-input type
  - Thermocouple (TC):  
J, K, R, B, T, E, S, N, U, WRe5-26, PL-II
  - Platinum resistance bulb (RTD):  
Pt 100Ω
  - Voltage/Current: DC1 to 5V/0 to 5V/4 to 20mA
- Input accuracy: ±0.5% of full scale, ±1 digit (±1°C at thermocouple)
 

B (TC) 0 to 500°C : ±5% of full	}	scale
R (TC) 0 to 400°C : ±1% of		
- Input sampling cycle:  
0.5sec
- Control action: Fuzzy control or PID with auto-tuning
- Control output:
  - Relay contact
  - Voltage pulse output (for SSR drive)
  - Current output
- Alarm output: 2 points max. (ALM1, ALM2)
- Operation mode:
  - Fixed value operation
  - Manual operation
- Option
  - Re-transmission analog output: 1 point
  - Communication function: RS-485  
Modbus® or CC-data line protocol.
  - Programmable alarms: 2 points max.
  - Dual output
  - Heater break alarm: 1 point
  - Ramp/soak function: 4 ramp/soak-pair patterns
  - Auxiliary digital input: 1 point
  - Remote SV input: 1 point

## FUNCTION AND PERFORMANCE

### 1. Input

- (1) Process variable input signal

Kind of input	Description
Thermocouple J K R B T E S N (Nichrosil-Nisil) U WRe5-26(Tangsten rhenium) PL-II (Platinel)	<ul style="list-style-type: none"> <li>• Cold junction compensation comprised</li> <li>• Burn-out circuit built in</li> </ul>
Resistance bulb Pt 100	<ul style="list-style-type: none"> <li>• Burn-out circuit built in</li> <li>• Allowable wiring resistance 10Ω max. (per wire)</li> </ul>
Voltage 1 to 5V DC 0 to 5V DC	Input resistance 1MΩ min.
Current 4 to 20mA DC	Input resistance 250Ω

Remarks: (1) For 4 to 20mA DC input specification, a 250 Ω resistor is furnished with the controller delivered.

(2) The 250Ω resistor should be removed for changeover from 4 to 20mA DC to 1 to 5V DC input.

(a) **Input accuracy:** ±0.5% of full scale, ±1 digit  
Cold junction compensation error:  
±1°C

(b) **Input range**

Kinds of input	Code	Temperature range [°C]	Temperature range [°F]	0.1°C	0.1°F	
Resistance bulb JIS IEC	Pt100	00	0 to 150	32 to 302	○	○
		01	0 to 300	32 to 572	○	○
		02	0 to 500	32 to 932	○	○
		03	0 to 600	32 to 1112	○	×
		04	-50 to 100	-58 to 212	○	○
		05	-100 to 200	-148 to 392	○	○
		06	-150 to 600	-238 to 1112	○	×
		07	-150 to 850	-238 to 1562	○	×
Thermo-couple	J	20	0 to 400	32 to 752	○	○
	J	21	0 to 800	32 to 1472	○	×
	K	22	0 to 400	32 to 752	○	○
	K	23	0 to 800	32 to 1472	○	×
	K	24	0 to 1200	32 to 2192	×	×
	R	25	0 to 1600	32 to 2912	×	×
	B	26	0 to 1800	32 to 3272	×	×
	T	27	-199.9 to 200	-328 to 392	○	×
	T	28	-150 to 400	-238 to 752	○	×
	E	29	0 to 800	32 to 1472	○	×
	E	2A	-199.9 to 800	-328 to 1472	○	×
	S	2B	0 to 1600	32 to 2912	×	×
	N	2C	0 to 1300	32 to 2372	×	×
	U	2D	-199.9 to 400	-328 to 752	○	×
	WRe5-26 PL-II	2E	0 to 2300	32 to 4172	×	×
		2F	0 to 1300	32 to 2372	×	×
Voltage 1 to 5V DC 0 to 5V DC	40 41	Scale settable within -1999 to 9999				
Current 4 to 20mA DC	40*	(*Connect 250Ω between terminal No.9 and 10 in case of current input				

(c) **Input sampling cycle:** 0.5sec

(d) **Burn-out**

- Control output direction (upper side or lower side) is programmable at occurrence of burn-out.
- For resistance bulb input, detection is allowed even if any of the three wires is discontinued.

(2) **Digital input (option)**

Number of input points: 1 point  
Spec. : DC 16V, 15mA

(3) **Remote SV input (option)**

Input signal: 1 to 5V DC, 1 point  
Accuracy: ±0.5% ±1 digit  
Input sampling cycle: 0.5sec  
Input scaling: Allowed  
Input filter: First delay (time constant 1sec fixed)  
Display of remote mode: LED on front panel  
Detection of input signal wire discontinued: None  
Changeover Remote/Auto: Bumpless

**2. Control functions**

(1) **Fuzzy control:** The basic actions in PID control have been

realized according to fuzzy control rules.

(2) **PID control with auto-tuning:**

Proportional band (P): 0 to 999.9%  
(2-position action when P = 0)  
Integral time (I): 0 to 3200sec  
(Integral action cut when I = 0)  
Derivative time (D): 0 to 999.9sec  
(Derivation action cut when D = 0)

(Fuzzy control action or PID action with auto-tuning is selectable by using the front panel key. : CTRL parameter)

(3) **Proportional cycle:** 1 to 120sec

(4) **Control cycle:** 0.5sec

**3. Output**

(1) **Control output**

– **Standard type –**

Of the following output types, any one should be specified.

Relay contact output	Normally open SPST or SPDT contact (*)	Electrical expected life : More than 10 <sup>5</sup> operations at 220V AC, 3A (resistive load)  Mechanical expected life : More than 2 x 10 <sup>7</sup> operations
SSR drive output	Transistor output	ON: DC9 to 24V, 20mA max. OFF: 0.5V or less Load resistance : 600Ω or more
Current output	4 to 20mA DC	Allowable load resistance : 600Ω or less Output accuracy : ±5.0% of full scale

Note: (\*) Need to be specified in CODE SYMBOL

– **Dual output type –**

Of the following output types, any one should be specified for each of the heating and cooling sides.

Relay contact output	Normally open SPST contact	Electrical expected life : More than 10 <sup>5</sup> operations at 220V AC, 3A (resistive load)  Mechanical expected life : More than 2 x 10 <sup>7</sup> operations
SSR drive output	Transistor output	ON: DC9 to 24V, 20mA max. OFF: 0.5V or less Load resistance : 600Ω or more

(2) **AO re-transmission (option)**

- Number of output points: 1 point
- Output data: Any of process variable, set value or manipulated variable
- Output accuracy: ±0.5% of full scale
- Kind of output : 1 to 5V DC
- Add-on function: Scaling function

**4. Setting and indication**

(1) **Accuracy:** ±0.5% of full scale, ±1 digit (±1°C at TC)  
B (TC) 0 to 500°C : ±5% of full scale  
R (TC) 0 to 400°C : ±1% of full scale

(2) **Setting method:**  
Key operation

(3) **Indication method:**  
Numerical display; Each of PV and SV independently displayed (PV: Red, SV: Green)

(4) **Status indication:**  
Control outputs 1 and 2  
Alarms 1 and 2  
Remote SV

**5. Alarm (option)**

(1) **Upper/lower limit alarm:**

Desired kind of alarm is selectable from Fig. 1 by using the front panel key.

Alarm output: 2 points (\*)

Relay contact output	Normally open SPST contact	220V AC, 1A (resistive load)
----------------------	----------------------------	------------------------------

Note: \* Alarm output is limited to 1 point when SPDT contact is specified for control output 1.

## (2) Heater break alarm

- Discontinuation is detectable only when a signal-phase heater is used.
- Primary input of current transformer (CT)(\*) : 1 to 50A

Relay contact output	Normally open SPST contact	220V AC, 1A (resistive load)
----------------------	----------------------------	------------------------------

Note: \* The current transformer (CT) need be ordered separately from this controller (CT is installed outside the controller)

## 6. Protection from power failure

Set value, PID parameters, etc. are retained in the nonvolatile memory unit. Therefore, on power recovery, control restarts according to the values effective just before power failure.

## 7. Self-diagnosis

Program error is monitored with a watch dog timer.

## 8. Operating and storage conditions

- Allowable ambient temperature:**  
-10 to 50°C
- Allowable ambient humidity:**  
90% RH max. (free from condensation)
- Storage temperature:**  
-20 to 60°C

## 9. Rating specifications

- Power supply:** 100<sup>-15%</sup> to 240<sup>+10%</sup>V AC
- Power consumption:**  
About 10VA, 100V AC  
About 18VA, 240V AC
- Dielectric strength:**  
1500V AC for 1 minute between power terminal and:  
input terminal  
communication terminal  
output terminal  
relay terminal  
500V AC for 1 minutes (at other locations)
- Insulation resistance:**  
50MΩ min. (at 500V DC)

## 10. Physical data

- Installation method:**  
Flush on panel
- Enclosure:** Plastic housing
- External dimensions (H x W x D):**  
48 x 48 x 115 mm
- Mass {weight}:**  
Approx. 200 g
- Finish color:** Munsell N1.5 (black)
- External terminal:**  
Screw terminal M3.5

## 11. Scope of delivery

Controller and mounting bracket

【Item requiring separate order: Current transformer (CT) for heater break alarm】

## CODE SYMBOLS

1	2	3	4	5	6	7	8	9	10	11	12	13	Description	
P	Y	X	4	M										<b>Front panel size [mm]</b> 48 x 48
			4											<b>Kinds of input</b> TC/RTD/voltage/current
				M										<b>Control output 1</b> Without Relay(SPST reverse action) Relay(SPST direct action) SSR drive(reverse action) SSR drive(direct action) 4 to 20mA DC(reverse action) 4 to 20mA DC(direct action) Relay(SPDT reverse action) Relay(SPDT direct action)
				Y										<b>Control output 2</b> Without Relay(SPST reverse action) Relay(SPST direct action) SSR drive(reverse action) SSR drive(direct action)
				A										<b>Alarm function</b> 0 Without 1 1 point 2 2 points 3 HB detection 4 HB detection + 1 point
				B										<b>Input range code</b> See input range table in Page 2
				C										<b>Additional function</b> Y Without P SV selection command input(DI) Q 4 ramp/soak + start/reset R RS-485(*1)(Fuji original protocol) S RS-485(*1) +4 ramp/soak M RS-485(*2)(Modbus® RTU protocol) N RS-485(*2) +4 ramp/soak A Re-transmission B Re-transmission +4 ramp/soak C Remote SV
				D										<b>Front panel label</b> E English label in °C F English label in °F K English label in %

Note: \*1) Fuji Electric CC data line protocol.  
\*2) Modbus® RTU protocol.

Option combination

Code symbol	Column "7"	Column "9"				Column "12"									
	Control Output2	Alarm				Additional function									
	A	B	C	D	1	2	3	4	P	Q	R	S	A	B	C
Dual function					1 point	2 points	HB	HB+1 point	SV selection	4 ramp/soak+ start/reset	RS-485	RS-485+ 4 ramp/soak	Re-transmission	Re-transmission+ 4 ramp/soak	Remote SV
Combination	Yes	Yes	No	No	No	No									
	No	Yes	No	No	No	Yes									
		No	Yes*(1)	No	No	No									
		No	No	Yes*(2)	No	No									
	No	No	No	Yes*(3)	No										

Notes:\*(1):This selection is inhibited when Column "6" is "G" or "H"  
\*(2):This selection is inhibited when Column "6" is "C" or "D" or "E" or "F"  
\*(3):This selection is valid only when Column "6" is "A" or "B"

Kinds of alarm

Fig. 1

Function	Action	Alarm code	Alarm group	
Nothing	No Alarm	0	A	
High absolute alarm		1		
Low absolute alarm		2		
High deviation alarm		3		
Low deviation alarm		4		
High deviation alarm (invert)		5		
Low deviation alarm (invert)		6		
High/Low deviation alarm		7		
High/Low deviation alarm (invert)		8		
Low absolute alarm with hold		9		
Low deviation alarm with hold		A		
Low deviation alarm with hold (invert)		B		
High/Low deviation alarm with hold		C		
High/Low deviation alarm with hold (invert)		D		
SV High absolute alarm		E		
SV Low absolute alarm		F		
Nothing		0		B
Heater break		1		
Loop break		2		
Loop break + Heater break		3		

Remarks : (1) ASV : Alarm Setting Value

(2) alarm band

(3) What is "alarm with hold"?

Alarm does not live immedietly even when PV enters into alarm band.

After PV exits from alarm band and re-enters into alarm band, alarm fires.

(4) SV High absolute alarm/Low absolute alarm are effect only with Remote SV function.

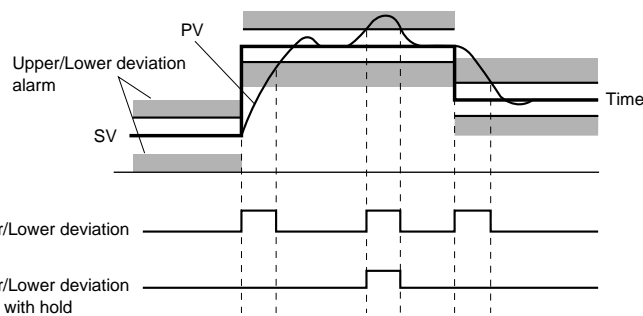

Multi-alariming

It allows a maximum of 4 types of alarm settings (among which, one is dedicated to loop/heater disconnection), detects those types of alarm individually, and makes logical OR before outputting it to the alarm relay. (Multi-alarm)

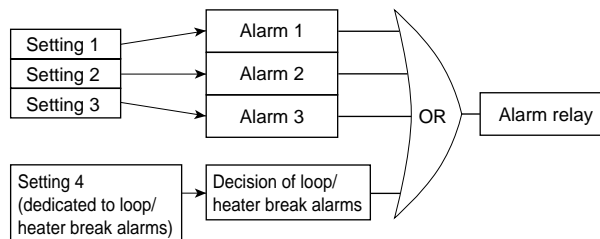

Operation procedure

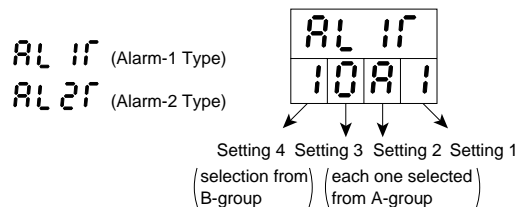

Note:

For the setting in the above figure the result of ORING of the heater break alarm, "holding"-featured low-limit deviation alarm, and high-limit absolute alarm is output

## SETTING METHOD

### 1. SV setting

#### (1) Method 1

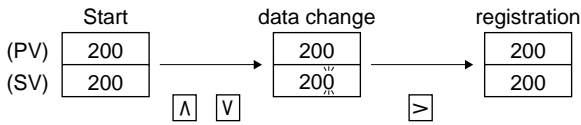

or : The first digit flashes to allow inc or dec of data.

#### (2) Method 2

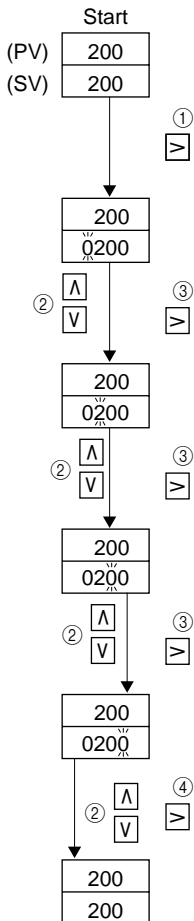

① SV change mode

② Inc or dec data in the flashing digit by key.

③ Shift flashing digit to right by key.

④ Registration of the setting value by key.

### 2. How to assign parameters

#### (1) Calling parameters

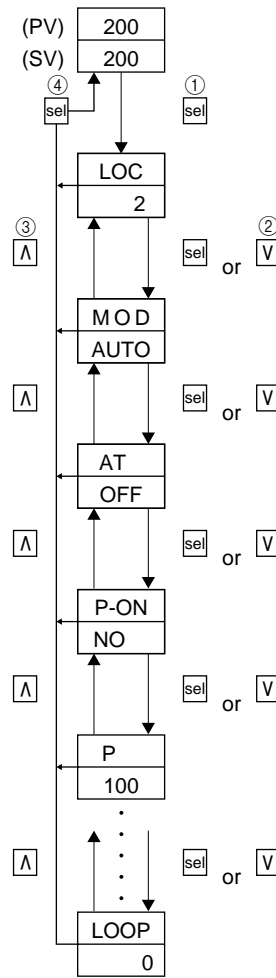

① Keep key pressed for about 3 sec. in PV/SV display condition.

② Press key for parameter change.

③ Press key for reverse direction.

④ Keep key pressed for about 3 sec in parameter display mode, back to PV/SV mode.

#### (2) Data changing

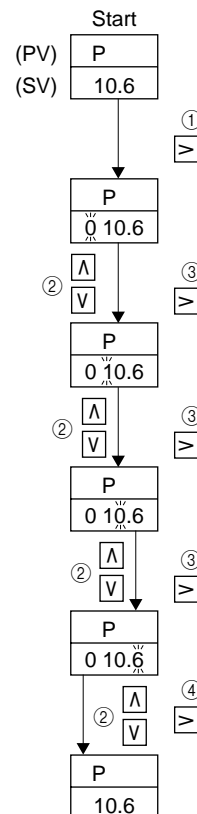

① P change mode

② Inc or dec data in the flashing digit by key

③ Shift flashing digit to right by key.

④ Registration of the setting value by key.

Parameter sheet for PYX

Lock level						
All locked	Only SV	End User	Set Maker			
0	1	2	3			
Dis-play				Mean of parameters	Range	Unit
####				Measured value (PV)	0~100%	Engineering unit
####				Setting value (SV)	0~100%	Engineering unit
####				Manual manipulated variable (MV)	-3~103%	%
LOCK				Lock for other parameters	0~3	
			CAS	Remote SV input value	0~100%	Engineering unit
			OUT 1	MV for output 1	-3~103%	%
			OUT 2	MV for output 2	-3~103%	%
		MOD		Mode of control	AUTO MAN REM	
	AT			Auto tuning command	OFF ON LOW	
		D-SV		Second SV	0~100%	Engineering unit
	STAT			Ramp / Soak location	OFF 1-RP 1-SK 2-RP 2-SK 3-RP 3-SK 4-RP 4-SK END	
	TIME			Ramp / Soak rest time	0.0~99.59/ 100h	HH. mm
	PROG			Ramp / Soak command	OFF RUN HOLD (END)	
	SV1			1st. target point (SV)	0~100%	Engineering unit
	TM1R			Time of 1st. Ramp segment	0.0~99.59	HH. mm
	TM1S			Time of 1st. Soak segment	0.0~99.59	HH. mm
	SV2			2nd. target point (SV)	0~100%	Engineering unit
	TM2R			Time of 2nd. Ramp segment	0.0~99.59	HH. mm
	TM2S			Time of 2nd. Soak segment	0.0~99.59	HH. mm
	SV3			3rd. target point (SV)	0~100%	Engineering unit
	TM3R			Time of 3rd. Ramp segment	0.0~99.59	HH. mm
	TM3S			Time of 3rd. Soak segment	0.0~99.59	HH. mm
	SV4			4th. target point (SV)	0~100%	Engineering unit
	TM4R			Time of 4th. Ramp segment	0.0~99.59	HH. mm
	TM4S			Time of 4th. Soak segment	0.0~99.59	HH. mm
		P-ON		Auto start demand when turn on for Ramp/Soak	NO YES	
		P		Proportional Band	0.0~999.9	%
		HYS		Hysteresis for two step control	0~100%	Engineering unit
		I		Reset time	0~3200	Second
		D		Rate time	0~999.9	Second
		COOL		Rate of Proportional Band for cooling	0.0~10.0	
		DB		Dead Band/ Overlap	-50~50%	%
		AR		Anti-Reset Wind-up	0~100%	Engineering unit
		MAN		Manual Reset value	-100.0~100.0	%
		AL1T		Alarm actions for Alarm 1	0000~(*1) 3FFFh	
		AL11		Set value for Alarm 11	0~100%	Engineering unit

Lock level						
All locked	Only SV	End User	Set Maker			
0	1	2	3			
Dis-play				Mean of parameters	Range	Unit
			A11H	Hysteresis for Alarm 11	0~100%	Engineering unit
			AL12	Set value for Alarm 12	0~100%	Engineering unit
			A12H	Hysteresis for Alarm 12	0~100%	Engineering unit
			AL13	Set value for Alarm 13	0~100%	Engineering unit
			A13H	Hysteresis for Alarm 13	0~100%	Engineering unit
			AL2T	Alarm actions for Alarm 2	0000~(*1) 3FFFh	
			AL21	Set value for Alarm 21	0~100%	Engineering unit
			A21H	Hysteresis for Alarm 21	0~100%	Engineering unit
			AL22	Set value for Alarm 22	0~100%	Engineering unit
			A22H	Hysteresis for Alarm 22	0~100%	Engineering unit
			AL23	Set value for Alarm 23	0~100%	Engineering unit
			A23H	Hysteresis for Alarm 23	0~100%	Engineering unit
			LOOP	Time for Loop break detection	0.0~99.59	MM. ss
			HB-A	Current setting for Heater break detection	1~50	Amp.
			CT	Heater Current indicated value	0~50	Amp.
			PVT	Input type/Decimal point/Temp. Unit	0000~4111h (*2)	Code No.
			PVF	Upper scale for PV	-1999~9999	1 word DEC
			PVB	Lower scale for PV	-1999~9999	1 word DEC
			PVD	Decimal point position	0~2	1 byte DEC
			TF	Rate of Digital Filter	0.0~900.0	Second
			SFT	PV offset	-50~50%	Engineering unit
			SV-H	High limit setting of SV	0~100%	Engineering unit
			SV-L	Low limit setting of SV	0~100%	Engineering unit
			REMF	Upper scale of Remote SV	0~100%	Engineering unit
			REMB	Lower scale of Remote SV	0~100%	Engineering unit
			CTRL	Kind of control	FUZY PID	
			DT	Cycle of computing	0.5	Second
			REV-1	Control action for output 1	NORM REV	
			REV-2	Control action for output 2	NORM REV	
			TC-1	Proportional Cycle for output 1	1~120	Second
			TC-2	Proportional Cycle for output 2	1~120	Second
			MV-H	High limit of MV	-3~103%	%
			MV-L	Low limit of MV	-3~103%	%
			BURN	Action when input is abnormal	0~4	
			AOT	Kind of Analog output source	PV SV	
			AO-H	Upper scale of AO	0~100%	%
			AO-L	Lower scale of AO	0~100%	%
			STNO	Station No. for communication	1~15	

Notes : (\*1) : Hexa decimal code : refer to "Kinds of alarm" (page 4).  
 (\*2) : Hexa decimal code : refer to "Input range" (page 2).

## FUNCTIONS

### (1) Fuzzy feedback control

Fuzzy feedback control expresses the basic actions of PID control in fuzzy rules and has a nonlinear characteristic in order to straighten out the problem inherent to PID control (i.e., overshoot occurs when improving response or instability arises due to a change in system even when optimum PID parameters are assigned).

- Comparison of controllability  
Each result of fuzzy control and PID control is shown below.  
It is understandable that the overshoot due to a change of set value has been suppressed in fuzzy control.

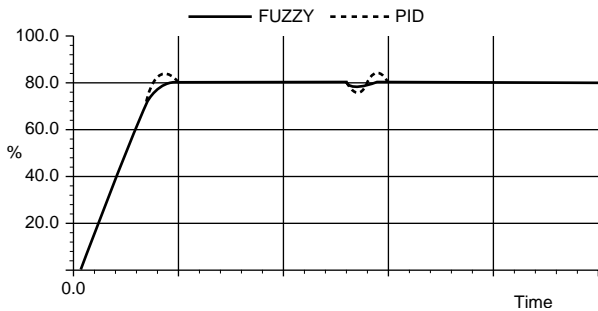

### (2) Ramp soak function (option)

Function to automatically change the set point value with elapsing of time, in accordance with the preset pattern, as shown below. This device allows maximum of 4 ramp soak programs.

This first ramp starts at the value measured immediately before the program is executed (PV).

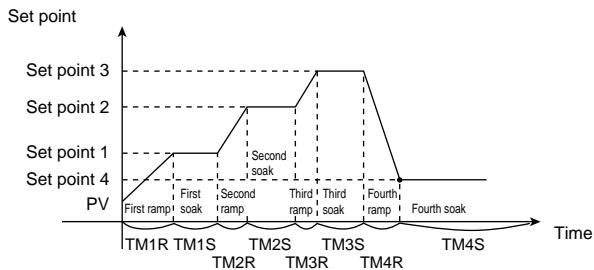

Ramp : Region in which the SP changes toward the target value.

Soak : Region in which the SP keeps unchanged at the target value.

Powering on can automatically trigger the program run (power-on start function), or an external contact signal can also do that.

### (3) Two set points (option)

Change set points digital input.

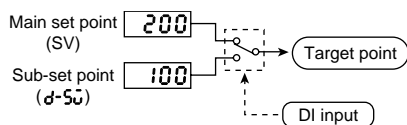

### (4) Auto-tuning

PID parameters are automatically set by controller's measurement and operation.

#### (a) Standard type

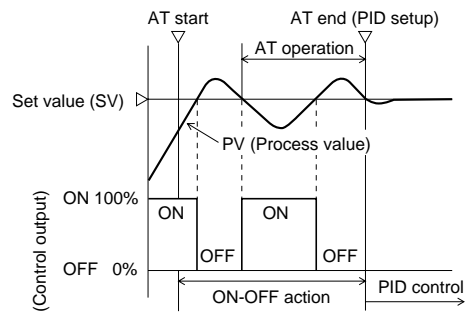

#### (b) Low PV type

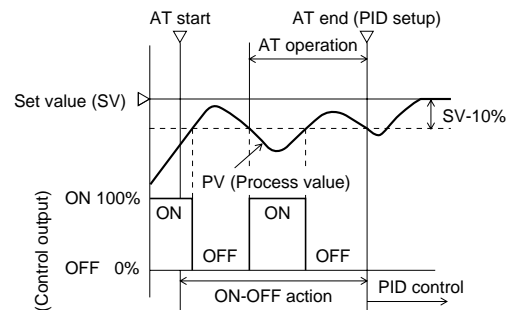

Remarks: (1) Once auto-tuning has been made, PID parameter values are retained despite power-off operation. Therefore, auto-tuning need not be repeated for the subsequent operations.

(2) During auto-tuning, control output corresponds to ON/OFF action. This may cause PV to change widely depending on process. If such a change is unallowable, auto-tuning should not be used.

(3) Do not use the auto-tuning function for a process having a quick response, such as pressure control, flow control, etc.

### (5) Anti-reset Windup (ARW)(\*)

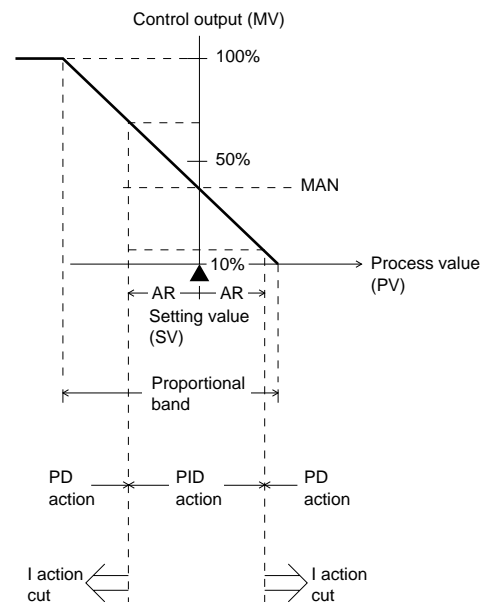

Note : \*ARW: INTEGRAL action is cut when PV is out range of AR value.

(6) Dual output (option)

The controller incorporates both the heating output and the cooling output for setting "cooling control cycle", "cooling proportional band" and "dead band or overlap band".

(a) Setting of cooling proportional band

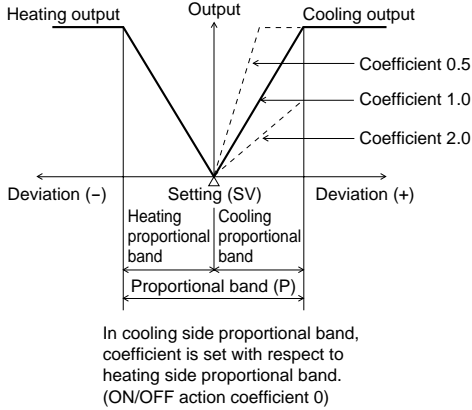

(b) Setting of dead band or overlap band

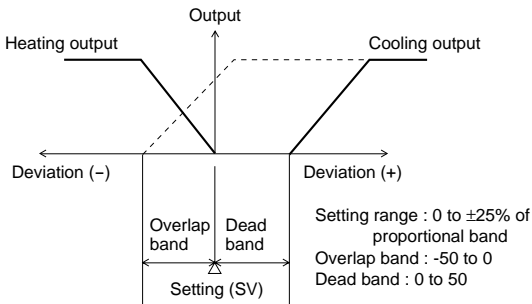

Remarks:

- (1) PID auto-tuning is carried out only on the heating side. During auto-tuning, output on the cooling side remains turned off. After auto-tuning, both heating and cooling operations are performed according to the same PID values.
- (2) ID set value is the same between heating and cooling sides. Individual setting cannot be accepted.

(7) Heater break alarm (option)

- Use the current transformer (CT) specified by Fuji.
- Heater break is detected only when single-phase heater is used.
- Heater break alarm is not available when controlling the heater by thyristor phase-angle control method.
- [alarm detection point] and [Heater current] are registered using of front key.

• Example of connection of heater break alarm

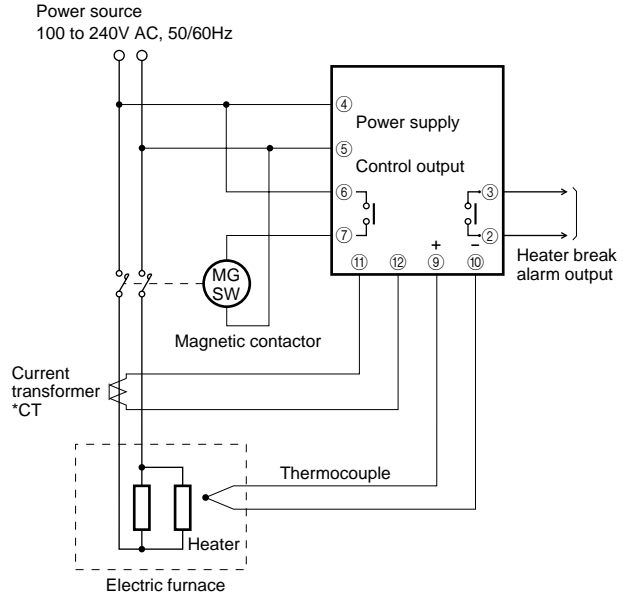

(8) Error message

Display	Cause
UUUUU	(1) Thermocouple disconnection (2) RTD disconnection (3) Above 105% of input signal
LLLLL	(1) Thermocouple disconnection (lower direction setting in burnout) (2) RTD disconnection (lower direction setting in burnout) (3) Short circuit between A and B of RTD (4) Below -5% of input signal



## OUTLINE DIAGRAM (Unit:mm)

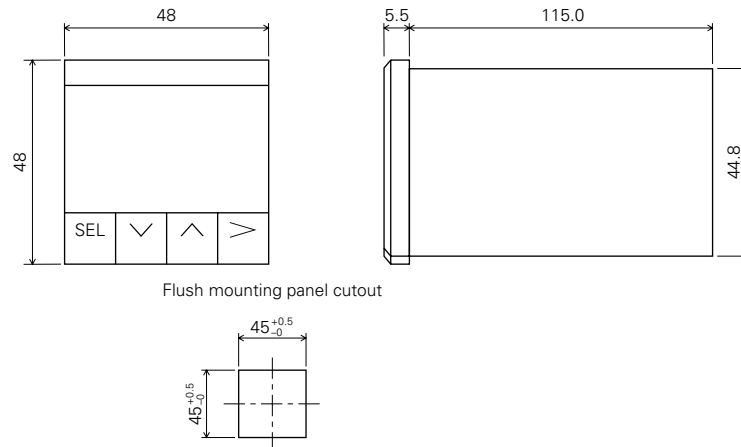

### CAUTION OF SAFETY

First of all, read this "Caution on Safety" carefully, and then use the instrument in the correct way.

The cautionary descriptions listed here contain important information about safety, so they should always be observed. Those safety precautions are classified in 2 ranks, WARNING and CAUTION.

The following shows the meaning of WARNING and CAUTION.

	WARNING	Wrong handling may cause a dangerous situation in which there is 2 possibility of death or heavy injury.
	CAUTION	Wrong handling may cause a dangerous situation in which there is a possibility of injury or physical damage.

### WARNING

For the safe operation of the controller, where the temperature probe is to be installed into an environment where voltages exceed 50 VDC, it is essential that reinforced isolation or basic isolation and earth is maintained between all connections to the rear of the temperature controller, and that supplementary isolation is required for the alarm outputs.

The outputs from the controller are all less than 50 VDC.

When wiring the power supply terminal, use vinyl insulated 600 volt cable or equivalent. A switch breaking both poles of the mains supply should be installed together with a fuse with a rating of 250volt 1Amp. The fuse should be installed between the mains switch and the controller.

The level of insulation provided by the temperature controller is;

MAINS=BASIC  
HEATER=BASIC  
INPUTS=BASIC

Prior to operation of the installed system the wiring should be checked to ensure that the required levels of insulation have been provided.

■ TERMINAL WIRING

(1) Normally open SPST contact

(Control output 1)

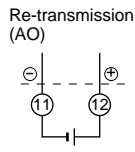
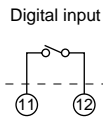

(Control output 2)

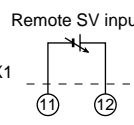
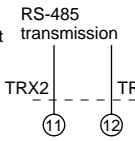
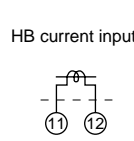
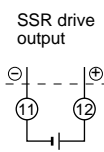

Alarm 2 output or HB alarm  
Alarm 1 output or HB alarm  
Common  
Power supply 100 to 240V AC 50/60Hz

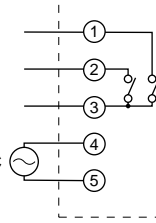

Relay output

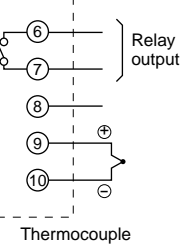

(Control output 1)

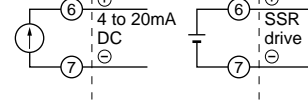

[Process input]

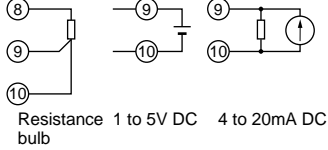

(2) SPDT

(Control output 1)

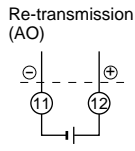
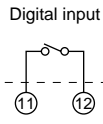

(Control output 2)

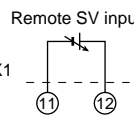
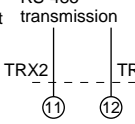
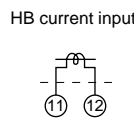
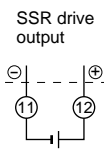

(Control output 1)

(normally close)  
Alarm 1 output or HB alarm  
Common  
Power supply 100 to 240V AC 50/60Hz

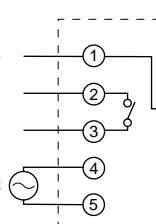

Relay output

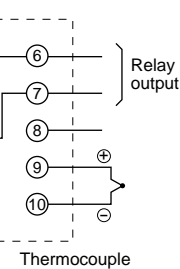

(Control output 1)

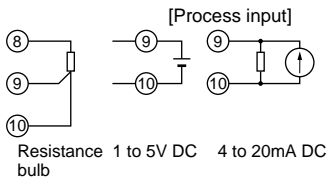

ORDERING OF CURRENT TRANSFORMER

Current transformer for heater break

Specification : For 20 to 50A  
Ordering code : CTL-12-S36-8F

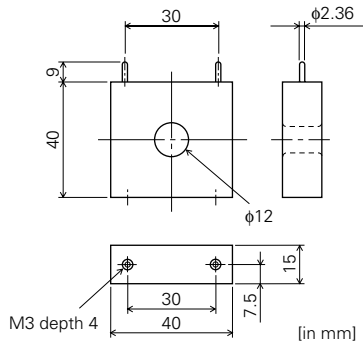

Specification : For 1 to 30A  
Ordering code : CTL-6-SF

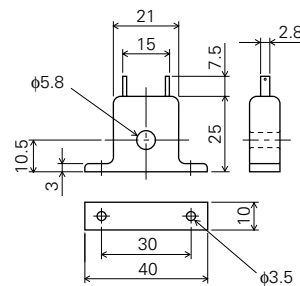

Fuji Electric Co.,Ltd.

Head office

11-2 Osaki 1-chome, Shinagawa-ku, Tokyo, 141-0032 Japan  
Phone: 81-3-5435-7111  
<http://www.fujielectric.co.jp/eng/sg/KEISOKU/welcome.htm>

Fuji Electric Instruments Co.,Ltd.

Sales Div.

International Sales Dept.

No.1, Fuji-machi, Hino-city, Tokyo, 191-8502 Japan  
Phone: 81-42-585-6201, 6202  
Fax: 81-42-585-6187, 6189