



FUJI
ELECTRIC
Fuji Electric France S.A.

A New Generation of Pressure Transmitters



Series AII/CII



A New addition to the FCX Family at the edge of Technology

As a leader in the field of pressure measurement, Fuji Electric has an installed base of more than 750,000 FCX transmitters all around the world. Using leading edge technology in silicon chip manufacturing, FCX transmitters incorporate a high performance micro capacitance silicon sensor. This sensor is machined into the silicon to create the unique floating design which gives the transmitters robustness and an unbeatable accuracy specification. In response to customer demand Fuji Electric has developed two variations of the transmitter. Firstly, the FCX AII series which is a high performance transmitter, designed to solve the toughest of applications where special materials and design is needed. Secondly the FCX CII series which is a high accuracy transmitter designed as an economic solution to most applications. The combination of FCX AII/CII transmitters allows us to offer a variety of measuring ranges built and configured to meet individual application requirements in most industrial markets.

FCX-CII

FCX-AII

Our facility at Fuji Electric France SA was formed in 1995 and within 18 months was accredited with ISO quality certification - AFAC in November 1997. The last update of the ISO 9001 : 2000 standard was successfully completed in October 2003 and provides quality assurance for our sales and manufacturing activities.



Approvals

SIL - PED

NAMUR- NACE

GOST - ATEX

FM - CSA - JIS

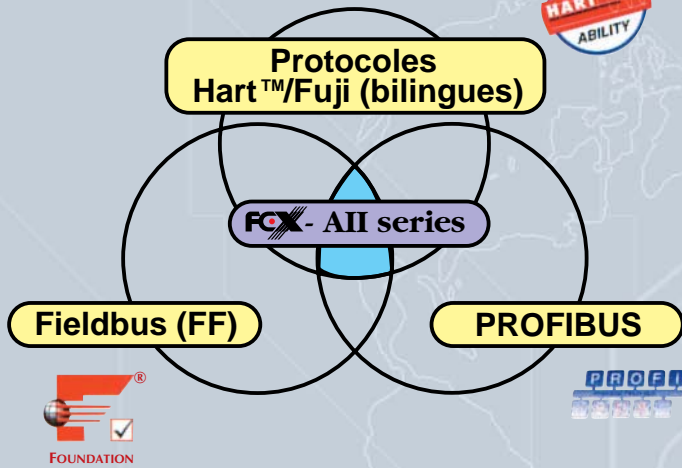

The Fuji Electric hand held communicator (HHC) is a very useful configuration tool for FCX AII/CII series transmitters. As a menu driven device the HHC can be used to remotely display and configure transmitter parameters:

- ◆◆ Principle programmable parameters :
 - Zero
 - Span
 - Burnout
 - Output signal
 - Auto diagnostic
 - Type of output signal (linear or square root)
 - Damping
 - Current generation
 - Tag
 - Model number of the transmitter
- ◆◆ Liquid crystal display using 4 lines and 16 characters
- ◆◆ Intrinsically safe
- ◆◆ Printer as an option

All FCX AII & CII are transmitters are "Smart" and provide 4 to 20 mA & superposed digital signals. The transmitters use bilingual language capability which uniquely provide Hart and Fuji protocol as standard. In addition FCX AII & CII can be supplied to communicate using either Foundation Fieldbus H1 or Profibus PA protocols.

Using the Hart™ communication protocol the FCXAII/CII transmitters can also be configured by any Hart protocol compatible hand held.

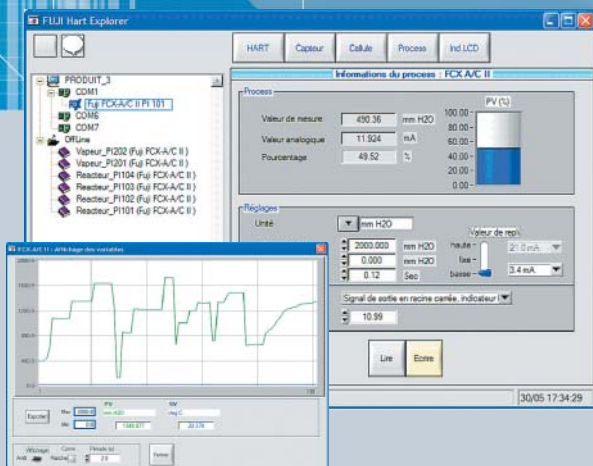

FCX AII/CII series pressure transmitter can also be configured using Hart™ communication based software connected to your Laptop or PC. Configuration of the above parameters is possible and the settings can also be saved for future reference.

It is also possible to measure and record process values. The interface between the PC and the transmitter is performed by a mini modem USB/Hart to guarantee the communication between the PC and the 4 to 20 mA loop of the transmitter.

Silicon sensor, a micro capacitance based technology

Accuracy: +/- 0.07%
Of calibrated span (FCX AII)

Long term stability: +/- 0.1%
Of max. span/3years

Based on our extensive silicon chip manufacturing experience, Fuji Electric developed the unique micro capacitance silicon sensor as the centrepiece of FCX AII/CII transmitters. The silicon sensor is mounted floating in the measuring cell neck to minimize the static pressure and temperature effect (4.5 times better than a conventional sensor) which provides an improved signal to noise ratio.

As a measuring diaphragm material, the sensor uses a single crystal silicon that has minimal hysteresis and fatigue which improves the transmitter's characteristics improving long term stability and reliability. FCX transmitters FCXAII/CII comply with manufacturing quality control according the ISO 9001 requirements.

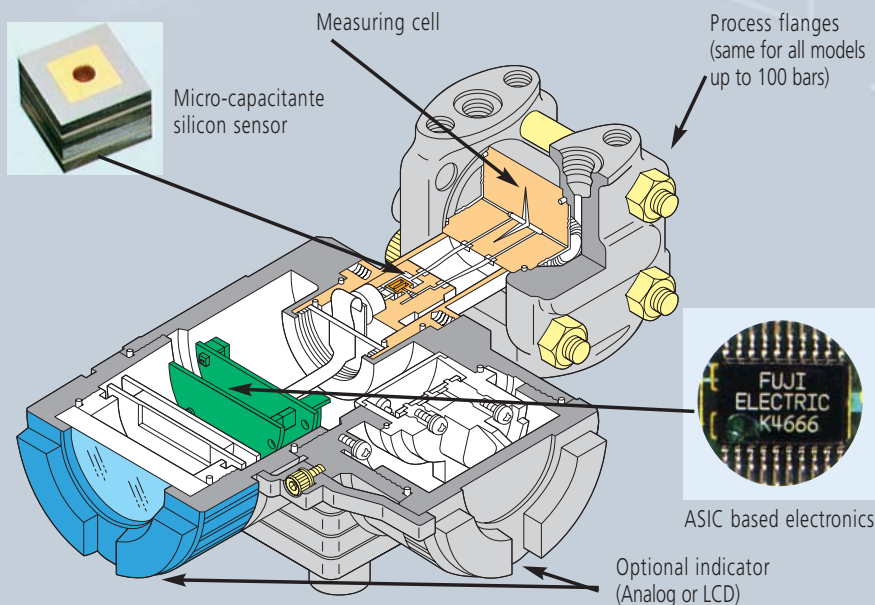

ASIC Technology

In developing the series FCXAII/CII we used large scale integration (LSI) in a new ASIC, which contains both digital and analogue circuits. This further improves performance and reliability.

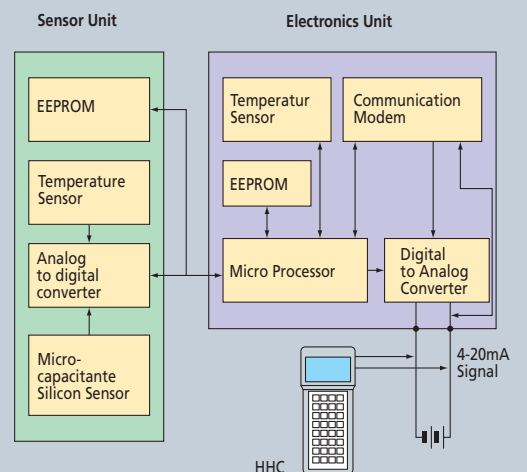

Full interchangeability

As individual configuration data of both, electronic unit (amplifier) and measuring cell, are stored separately in its own EEPROM, the interchangeability is guaranteed over the entire range of FCX transmitters series FCXAII/CII models including differential pressure, pressure, absolute pressure, level and remote seal transmitters. This allows a minimum stock of spare parts for maintenance.

Many additional configurations

Programmable output signal

The FCXAI/CII's output can be configured to provide linear or square root output. In addition the output signal can be configured using a 15 point linearization table to provide a non-linear output to suit specific applications, like the liquid volume measurements or non-symmetrical tanks or specific shapes.

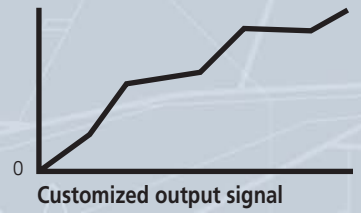
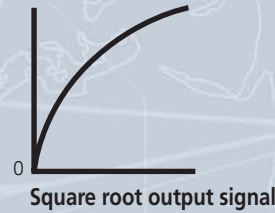
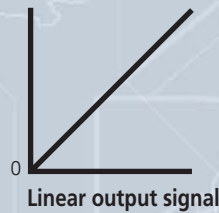

Application Example

Volume measurement of laid cylinder tank

Burnout current

In conformance with the recommendations of NAMUR NE 43 the output of the transmitter can be driven to a specific value should the transmitter experience an internal failure. The standard output signal limits are 3.8 to 20.8 mA and in case of a transmitter failure, the burnout direction can be either up or downscale being programmable between 20.8 and 21.6 and between 3.2 and 3.8 mA.

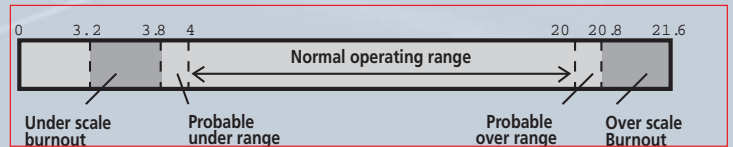

Digital Indicator

The FCXAI/CII models can be fitted with an optional local analogue, or digital indicator. The digital indicator is based on LCD technology and shows the information on 2 lines each of 6 digits and also includes 3 switches. The indicator can be used to show the output signal in engineering units, as a percentage or as a current in mA (this is useful for flow indication on a differential pressure transmitter). The type of measurement, the output signal and the value are shown on the screen (% , ZERO, DISP $\sqrt{\quad}$, OUT $\sqrt{\quad}$, FIX, \leftarrow , ABS, -, Facteur d'échelle). Three switches on the indicator allow the configuration and selection of adjustments:

- LOCAL/COMM : choice for local or remote adjustment
- DAMP : local adjustment of the damping
- MODE : Selection of Zero, Span and loop calibration local adjustment via the screw on the outside of the electronics housing

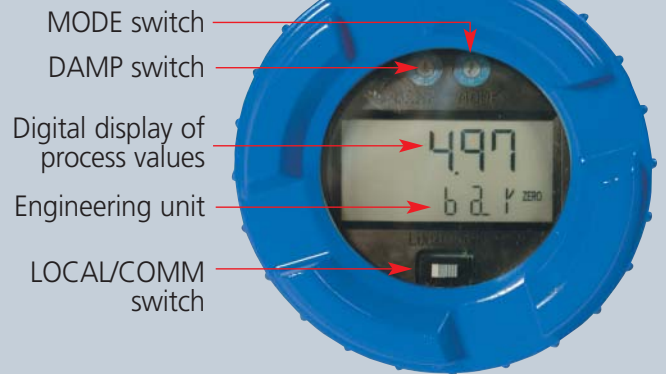

Easy Installation

The LCD indicator can be fitted in any one of 4 positions allowing it to be rotated 360° (90° steps). In addition the electronics housing can be rotated +/- 180° to suit all mounting positions and installations.

Special Applications

Pressure measurement

Gauge pressure transmitter with 1" – 150lbs diaphragm seal – all wetted parts in Tantalum (high corrosive applications)



Pressure measurement for sanitary, pharmaceutical ... applications with "In Line" seal, process connections are Tri Clamp.



Pressure measurement with sanitary diaphragm seal DN 50 according to DIN 11851.



Pressure measurement with DN 50 PN 40 diaphragm seal.



Level measurement

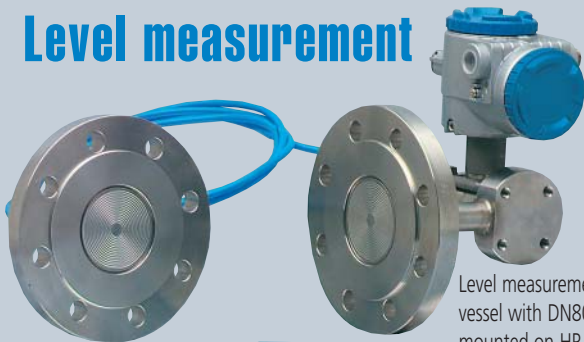

Level measurement on a pressurised vessel with DN80 PN40 seals direct mounted on HP side and capillary mounting on LP side.

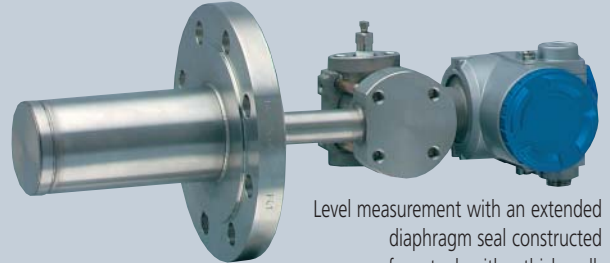

Level measurement with an extended diaphragm seal constructed for a tank with a thick wall.



Level transmitter DN80/PN40 - short design suitable for applications where installation space is restricted



Differential pressure or level measurement for special applications, wetted parts are gold plated, seal gasket face has a spigot.

Flow measurement

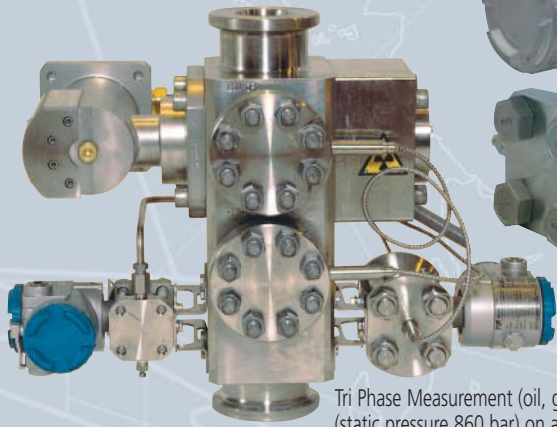

Tri Phase Measurement (oil, gas and water) with DP transmitter (static pressure 860 bar) on a Venturi and static pressure correction via GP transmitter. (PhaseWatcher Vx developed by Framo Engineering AS & Schlumberger).

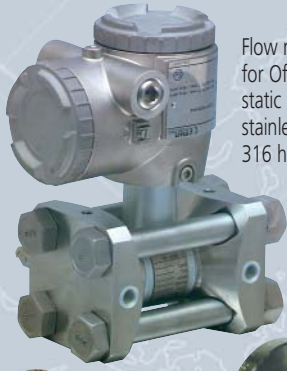

Flow measurement for Off Shore application, static pressure 860 bar, stainless steel 316 housing option.

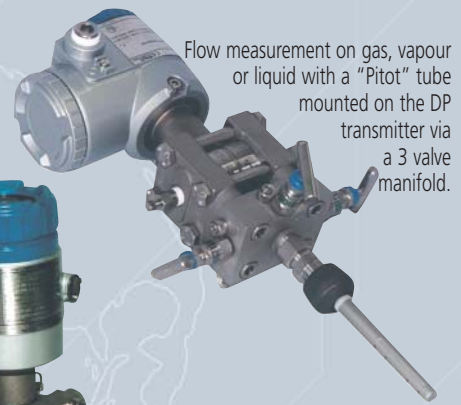

Flow measurement on gas, vapour or liquid with a "Pitot" tube mounted on the DP transmitter via a 3 valve manifold.



Integrated orifice, direct mounted on a DP transmitter for very low flow measurement for gas or liquid.

Custom built Transmitters

Fuji Electric's French manufacturing plant represents an extensive investment in specialised manufacturing plant and machinery. This allows us to produce custom built transmitters to meet very specific applications.



TIG welding : TIG (Tungsten Inert Gas) welding technology guarantees robust and reliable assemblies. These specialised welding facilities enable us to assemble the diaphragm seals, the capillaries and directly mount the seals on the transmitters. All welds are checked by a Helium tester to guarantee the integrity of the weld.



Machining Facilities: The numerous machining centres and specialist machines enable Fuji Electric to offer a very flexible production capability and to offer pressure transmitters with unbeatable delivery times.

CAD Facilities : New diaphragm seal designs and specific process connections are developed by the team of technicians and engineers meeting customer specifications, via state of the art Computer Aided design technology.



Calibration Benches : All Fuji Electric transmitters are calibrated on computer based automatic benches. The modern design of these high accurate benches ensure that even the slightest error is detected.



Clean Room : The manufacturing of the silicon measuring cell is the centrepiece of all FCX AII/CII transmitters. The assembly of the measuring cell is conducted in a class 10 000 clean room which provides the highest level of assurance. This facility adds to the design, machining, assembling and calibration of our product and allows us to control all aspects of the quality and guaranteed performance.



Spécifications



	FCX-AII					FCX-CII		
	Differential Pressure kPa (mbar)	Gauge Pressure kPa (bar)	Absolute Pressure kPa (bar)	Level Transmitter kPa (mbar)	Remote Seal Transmitter kPa (mbar)	Differential Pressure kPa (mbar)	Gauge Pressure kPa (bar)	Absolute Pressure kPa (bar)
Maximum Span	1 (10) 6 (60) 32 (320) 130 (1300) 500 (5000) 3000 (30000)	130 (1,3) 500 (5) 3000 (30) 10000 (100) 50000 (500)	16 (0,16) 130 (1,3) 500 (5) 3000 (30)	32 (320) 130 (1300) 500 (5000)	32 (320) 130 (1300) 500 (5000)	6 (60) 32 (320) 130 (1300) 500 (5000) 2000 (20000)	130 (1,3) 500 (5) 3000 (30) 10000 (100)	130 (1,3) 500 (5) 3000 (30)
Zero Elevation/ Suppression	-100% à +100% of max. span					-100% à +100% of max. span		
Rangability	100 : 1 depending on the max. span					16 : 1 depending on the max. span		
Max. Static pressure or max. Overpressure	3,2MPa (32bar) 10MPa (100bar) 16MPa (160bar) 42MPa (420bar) (see data sheets for details)	300% or 150% depending on max.range (see data sheets for details)	0,5MPa (5 bar) 1,5MPa (15bar) 9MPa (90bar) (see data sheets for details)	Up to the diaphragm seal flange rating		3,2MPa (32 bar) 14MPa (140bar) (see data sheets for details)	300% or 150% depending on max.range (see data sheets for details)	0,5MPa (5 bar) 1,5MPa (15bar) 9MPa (90bar) (see data sheets for details)
Accuracy in % of adjusted span	±0,07% (for standard spans, others please refer to the data sheet.)					±0,1%		
Temperature limits - process - ambient	- 40 to + 120 °C - 40 to + 85 °C					- 40 to + 100 °C - 40 to + 85 °C		
Wetted parts materials	SS 316 (L) SS / Hastelloy C-276 / Monel 400 / Tantal For details please refer to the data sheets					SS 316 L		
Output signal & power supply	4-20 mA dc and 10,5 -45 Vdc (power supply)							
Communication	FUJI and HART™							
Environmental protection	CEI IP67 and NEMA 4X							
Hazardous area certifications	ATEX, FM, CSA intrinsic safety and flame proof areas							
Available functions	1/ Burn out according NAMUR NE43 recommendation 2/ Linearization function (in 14 points) to linearize the output signal							
Options	1/ Local analogue or digital indicator, 2/ Arrestor (lightning protection), 3/ Stainless steel (SS 316) electronics housing, 4/ NACE requirements, 5/ High process temperature, vacuum service (for level and remote seal transmitters), 6/ Chlorine service, 7/ Diaphragm with gold or gold/ceramic coating for Hydrogen applications, 8/ SS bolts and nuts, 9/ PTFE process cover gasket, 10/ Tag plate, 11/ Side vents.							
Weight	4.4kg	3.4kg	3.4kg	12.4kg	14.4kg	3.4kg	1.9kg	1.9kg



FUJI ELECTRIC
Fuji Electric France S.A.

46, rue Georges Besse - ZI du Brézet - F-63039 Clermont-Ferrand Cedex 2 - FRANCE
Tél. France 04 73 98 26 98 - Fax. 04 73 98 26 99
Tél. International 33 4 73 98 26 98 - Fax. 33 4 73 98 26 99
E-Mail : sales.dpt@fujielectric.fr - http://www.fujielectric.fr